

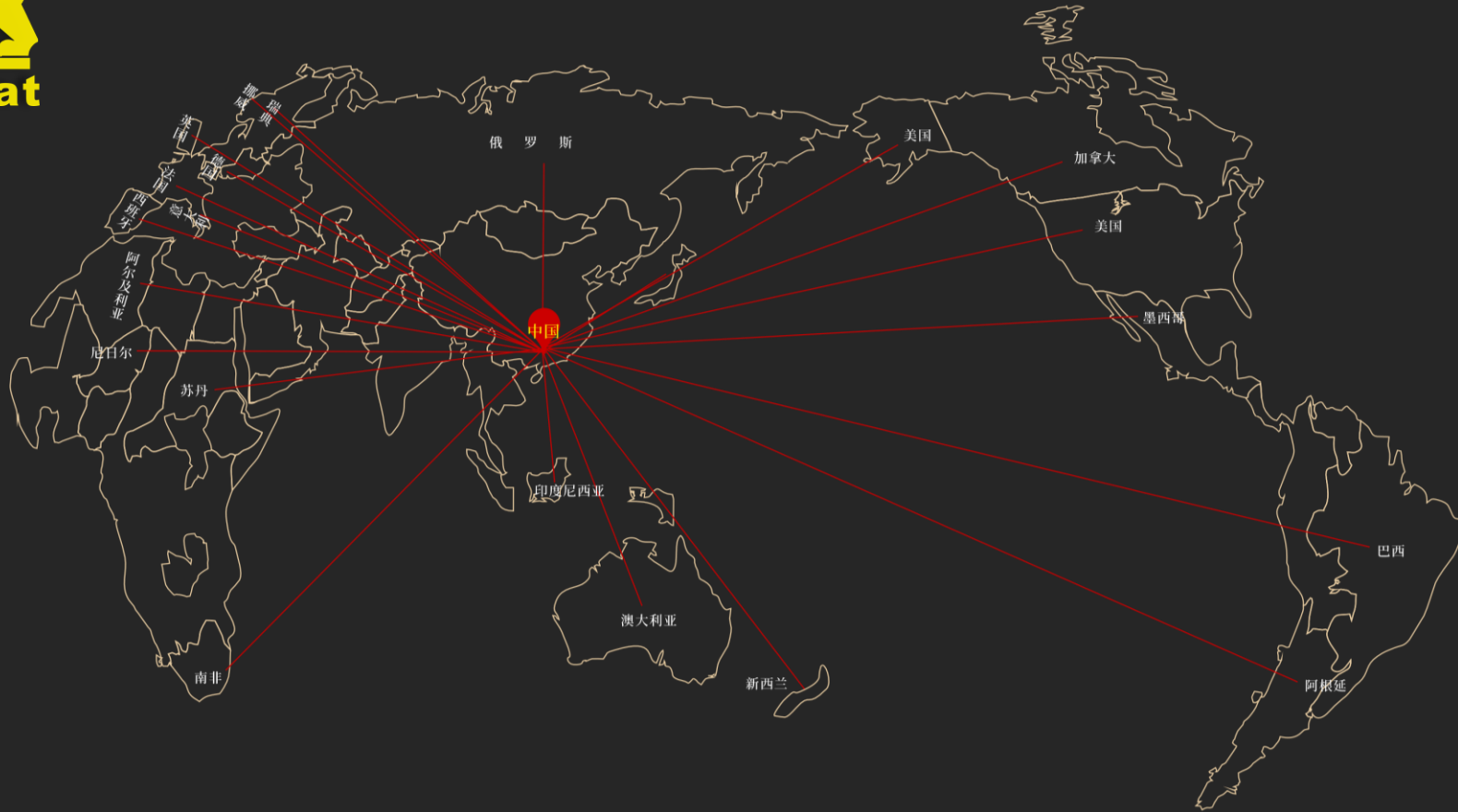

广东科励宝舞台设备有限公司
Guangdong Coreat Stage Equipment Co., Ltd

专注智能舞台机械
Focus on intelligent stage machinery



科励宝走向世界，产品和服务遍及100多个国家和地区
Coreat goes to the world with products and services in more than 100 countries and regions

目录

Contents

01

公司简介
Company Profile

02

企业文化
Corporate Culture

03

发展历程
History

04

企业荣誉
Corporate Honor

05

参展历程
Exhibiting History

06

团队介绍
Team Introduction

07

科励宝展厅
Gallery of Coreat

08

产品介绍
Product Introduction

09

服务领域
Service Areas

10

工程案例
Engineering Cases



公司简介/Company Profile

- 广东科励宝舞台设备有限公司，拥有4000多方的现代化花园式厂房，自2012年成立以来，凭借卓越的品质和技术创新，逐步发展成为集研发、设计、生产、销售、安装、调试及技术服务于一体的专业舞台智能机械设备生产企业，公司秉承着悠久的历史底蕴和丰富的行业经验，为国内外客户提供非凡的智能舞台机械设备。
 - 公司拥有专业的技术团队和一流的生产设备，始终将技术创新作为企业发展的核心驱动力，凭借多年的经验积累和技术创新，为国内外各类工程项目提供了高品质的舞台机械设备，我们实施严谨的品质管理，并且已通过欧盟国际CE认证、SGS检测、国家起重运输机械质量检测。产品有室内户外智能机械、高速表演升降机、威亚表演机械、LED屏创意动态机械、升降舞台、伸缩看台、数控电动葫芦等；广泛应用于礼堂剧院、演播厅、体育场馆、娱乐酒吧派对场、展览展示厅、流动演出、文旅项目等领域；舞台机械、电动葫芦等产品远销欧洲、美洲、亚洲、澳洲、非洲等五十多个国家和地区；并在多个方面取得了显著的科研成果，荣获多项专利技术，为国内外客户提供一站式解决方案。
 - 公司以优良的品质和严格的标准赢得了行业认可，受到社会各界的好评，是广东演艺设备行业商会理事单位、广东省广西商会演艺设备专业委员会执行会长单位。高质量的产品和过硬的服务在国际上备受专业用户的欢迎和推崇。
-
- Guangdong Coreat Stage Equipment Co.,Ltd, with more than 4000 modern garden-style factories, since its establishment in 2012, with excellent quality and technological innovation, it has gradually developed into a professional stage intelligent machinery and equipment manufacturer integrating R&D, design, production, sales, installation, commissioning and technical services. Adhering to the long history and rich industry experience, the company provides extraordinary intelligent stage machinery and equipment for customers at home and abroad.
 - The company has a professional technical team and first-class production equipment, always take technological innovation as the core driving force of enterprise development, with years of experience accumulation and technological innovation, provide high-quality stage machinery and equipment for various engineering projects at home and abroad, we implement strict quality management, and has passed the EU international CE certification, SGS testing, national lifting and transportation machinery quality testing. Products include indoor and outdoor intelligent machinery, high-speed performance lift, WIA performance machinery, LED screen creative dynamic machinery, lifting stage, telescopic stand, CNC electric hoist, etc.; widely used in auditorium theaters, studios, stadiums, entertainment bars, parties, exhibition halls, mobile performances, cultural tourism projects and other fields; Stage machinery, electric hoists and other products are exported to more than 50 countries and regions such as Europe, America, Asia, Australia, Africa and so on; and has achieved remarkable scientific research results in many aspects, won a number of patented technologies, and provided one-stop solutions for domestic and foreign customers.
 - The company has won industry recognition with excellent quality and strict standards, and has been praised by all walks of life. And is the director unit of Guangdong Performing Arts Equipment Industry Chamber of Commerce, Guangdong Province Guangxi Chamber of Commerce Executive Chairman Unit of Performing Arts Equipment Professional Committee. High-quality products and excellent service are welcomed and respected by professional users internationally.





企业使命/Corporate Mission

为客户创造价值，为员工创造平台，
为股东创造效益。

Create value for customers, create a
platform for employees,
Create benefits for shareholders.

经营理念/Business philosophy

诚信、务实、创新、超越、共赢。

Integrity, pragmatism, innovation,
transcendence, win-win.

03

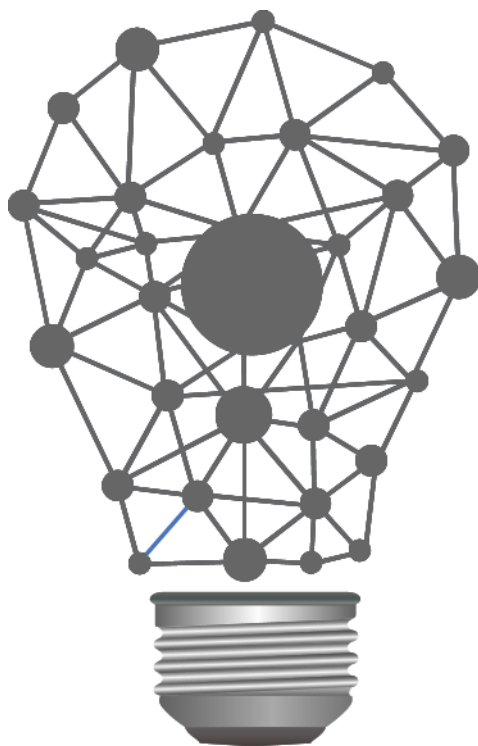

04

01

企业愿景Corporate vision

致力成为一流的舞台设备企业标杆。

Committed to becoming a first-class
stage equipment enterprise benchmark.

企业精神/Enterprise spirit

凝聚人才创新能力，团队协作，
勇于开拓，坚持不懈，共创辉煌。

Cohesion of talent innovation ability,
teamwork,
Have the courage to pioneer, persevere
and create brilliance together

02



发展历程/History

01

2012年

广州科励特舞台设备有限公司成立，欧洲标准舞台电动葫芦量产。成为国内第一家生产铝合金铸造外壳舞台电动葫芦的企业。

Guangzhou Coreat Stage Equipment Co., Ltd. was established, and the European standard stage electric hoist was mass-produced. Become the first enterprise in China to produce aluminum alloy cast shell stage electric hoist

02

2013年

成功申请电动葫芦外观设计专利、实用新型专利，非标定制舞台机械。

Successfully applied for electric hoist design patent and utility model patent, non-standard customized stage machinery.

03

2014年

进军国际市场，并扩大生产基地，成功开发钢结构拉深外壳电动葫芦及智能控制系统。

Entered the international market, and expanded the production base, successfully developed steel structure deep drawing shell electric hoist and intelligent control system.

04

2015年

自主研发智能铝合金结构旋转灯架量产，市场占有率60%以上。

Independent research and development of intelligent aluminum alloy structure rotating light stand mass production, market share of more than 60%.

05

2016年

稳步推进产品国际化、质量标准化。

Steadily promote product internationalization and quality standardization.

06

2017年

广西科励宝舞台设备有公司成立，扩展西南区域业务。

Guangxi Coreat Stage Equipment Company was established to expand business in the southwest region.

07

2018年

自主研发高端智能表演、展示类机械装置、智能控制系统。

Independent research and development of high-end intelligent performance, display mechanical devices, intelligent control system.

08

2019年

省级广东科励宝舞台设备有限公司成立，智能舞台机械进入全球市场，与众多国内高端娱乐场所合作。

The provincial Guangdong Coreat Stage Equipment Co., Ltd. was established, and intelligent stage machinery entered the global market and cooperated with many domestic high-end entertainment venues.

09

2020年

自主研发高端智能控制系统进入试验阶段，一体机研发。

Independent research and development of high-end intelligent control system into the test stage segment, all-in-one machine research and development

10

2021年

室内、户外各类光电视觉机械装置的研发。

Research and development of various photoelectric visual mechanical devices for indoor and outdoor use



发展历程/History

11

2022年

连续发明多个实用新型专利产品，并运用于娱乐、文旅、动态显示等领域。

Continuously invented a number of utility model patent products, and used in entertainment, cultural tourism, dynamic display and other fields.

12

2023年

多款高速Ethercat总线通讯 智能机械装置样板测试中。

A number of high-speed Ethercat bus communication intelligent mechanical device sample testing.



企业荣誉/Corporate honor

我司拥有产品各项检测认证、专利、资质，具有先进的创新水平，专业打造一流的产品。
Our company has various product testing certifications, patents, qualifications, advanced innovation level, professional to create first-class products.





参展历程/Exhibiting history

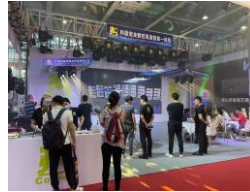

- | | | |
|-----|---------|-------------------|
| 1. | 2016-03 | GETshow广州展 |
| 2. | 2016-04 | 德国法兰克福展 |
| 3. | 2016-05 | 印度Palm Expo India |
| 4. | 2016-09 | 北京国际专业灯光音响展 |
| 5. | 2016-10 | 上海国际专业灯光音响展 |
| 6. | 2017-02 | GETshow广州展 |
| 7. | 2017-09 | 成都国际（音乐）演艺设备博览会 |
| 8. | 2017-10 | 上海国际专业灯光音响展 |
| 9. | 2018-05 | GETshow广州展 |
| 10. | 2018-09 | 成都国际（音乐）演艺设备博览会 |
| 11. | 2018-10 | 上海国际专业灯光音响展 |
| 12. | 2019-02 | 广州国际专业灯光音响展览会 |
| 13. | 2019-05 | GETshow广州展 |
| 14. | 2019-10 | 上海国际专业灯光音响展 |
| 15. | 2021-05 | GETshow广州展 |
-
- | | |
|-----|--|
| 1. | GET Show-Guangzhou |
| 2. | Frankfurt, Germany |
| 3. | Palm Expo India 2016 |
| 4. | Beijing International Professional Lighting and Sound Exhibition |
| 5. | Shanghai International Professional Lighting and Sound Exhibition |
| 6. | GET Show-Guangzhou |
| 7. | Chengdu International (Music) Performing Arts Equipment Expo |
| 8. | Shanghai International Professional Lighting and Sound Exhibition |
| 9. | GET Show-Guangzhou |
| 10. | Chengdu International (Music) Performing Arts Equipment Expo |
| 11. | Shanghai International Professional Lighting and Sound Exhibition |
| 12. | Guangzhou International Professional Lighting and Sound Exhibition |
| 13. | GET Show-Guangzhou |
| 14. | Shanghai International Professional Lighting and Sound Exhibition |
| 15. | GET Show-Guangzhou |



团队介绍/Team introduction



生产团队/Production team

我司拥有高效率，高产出生产团队，并配备专业生产设备，生产制造公差小，性能高的配件，皆为客户打造质量一流的产品。
Our company has a high-efficiency, high-output production team, and equipped with professional production equipment, manufacturing accessories with small tolerances and high performance, all of which create first-class quality products for customers.

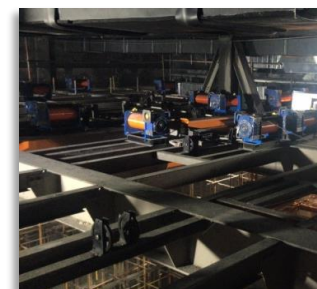
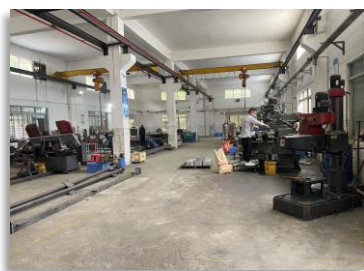

工程团队/Engineering team

我司工程部拥有多名经验丰富的机械专业设计师、电气专业设计师、安装工程师，是产品研发与设计的源泉力量。同时，我司配备经验丰富的安装团队，为客户提供质量保障。
Our engineering department has a number of experienced mechanical designers, electrical designers, installation engineers, is the source of product development and design. At the same time, our company is equipped with an experienced installation team to provide customers with quality assurance.



团队介绍/Team introduction

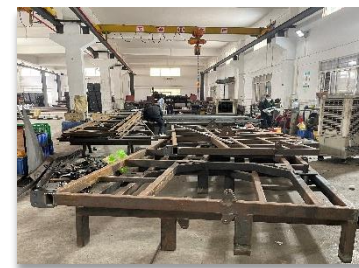

品质与效率/Quality and efficiency

一直以来，承蒙客户信赖，我们用一流的品质与效率回报客户：从原材料到部件再到成品，全程无死角的层层品检。做到承诺必达，急客户所急，建立一套有效管控品质与效率的动作系统。

We have always been trusted by our customers to repay them with first-class quality and efficiency: from raw materials to components to finished products, the whole process is full of quality inspection without dead ends. To achieve the promise must be achieved, urgent for customers, establish a set of effective quality control and efficiency action system.



科励宝展厅/Gallery of Coreat

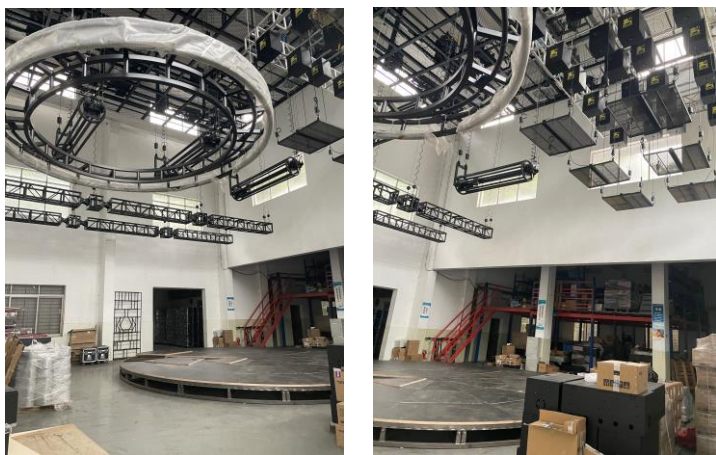

科励宝专属12米高空展厅
Exclusive 12-meter-high exhibition hall for Coreat



科励宝专属控制台/Exclusive console for Coreat

科励宝专属控制台/Exclusive console for Coreat

1677万色，画质细腻无痕，显示效果媲美液晶显示器下载、启动、运行，三位一体的超高速响应。

16.77 million colors, delicate picture quality without marks, display effect comparable to LCD display download, start, run, trinity of ultra-high-speed response

- 1.ARM9 CPU 400MHz主频，128MB存储容量
- 2.4.3~15.6英寸，1677万色TFT液晶显示，LED背光
- 3.2个COM口，独立通讯，支持RS232/RS422等通讯方式，可实现多屏一机
- 4.标配时钟
- 5.USB-B接口，实现数据传输
- 6.支持多种以太网通讯（支持与MODBUS TCP协议设备及西门子S7-1200PLC通过以太网通讯）

- 1.ARM9 CPU 400MHz main frequency, 128MB storage capacity
- 2.4.3~15.6 inches, 16.77 million colors TFT LCD display, LED backlight
- 3.2 COM ports, independent communication, support RS232/RS422 and other communication methods, can realize multi-screen one machine
4. Standard clock
5. USB-B interface to realize data transmission
6. Support a variety of Ethernet communication (support with MODBUS TCP protocol equipment and Siemens S7-1200PLC through Ethernet communication)



产品介绍 - 娱乐升降机/Product Introduction - Entertainment Lift

运用领域: 中大型舞美结构、灯光架、LED屏幕、灯条、灯具等中高载荷设备

Application areas: medium and large stage structures, lighting stands, LED screens, light strips, lamps and other medium and high load equipment

- ★ 高速总线绝对值伺服制动电机驱动/High-speed bus absolute value servo brake motor drive
- ★ 内置行程限位开关/Built-in stroke limit switch
- ★ 单层缠绕自动排绳/Single-layer winding automatic rope arrangement
- ★ 亚光黑机体/Matte black body

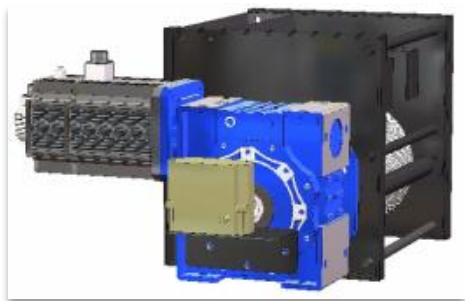

一体式单吊点自动排绳升降机

Integrated single lifting point automatic rope lift

技术参数/Technical parameters

供电电源/Power supply: 380V/50Hz,2.3KW/2.9KW/4.4KW/5.5KW/7.5KW

额定载荷/Load rating: 300kg/400kg/500kg/600kg/800kg

额定提升速度/Rated lifting speed: 0.3m—0.5/s

标准行程/Standard itinerary: 8m

系统使用寿命/System service life: 3000小时/hour

钢丝绳使用寿命/Wire rope service life: 500小时/hour

防坠绳使用寿命/Anti-fall rope service life: 1000小时/hour

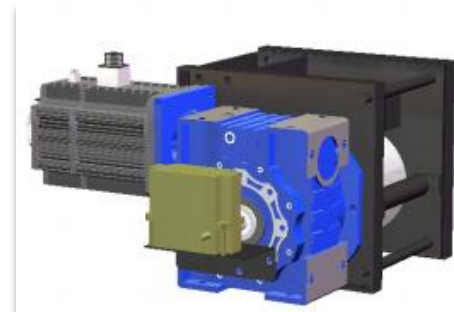

一体式双吊点自动排绳升降机

Integrated double lifting point automatic rope lift

技术参数/Technical parameters

供电电源/Power supply: 380V/50Hz,2.3KW/2.9KW/4.4KW/5.5KW/7.5KW

额定载荷/Load rating: 300kg/400kg/500kg/600kg/800kg

额定提升速度/Rated lifting speed: 0.3m—0.5/s

标准行程/Standard itinerary: 8m

系统使用寿命/System service life: 3000小时/hour

钢丝绳使用寿命/Wire rope service life: 500小时/hour

防坠绳使用寿命/Anti-fall rope service life: 1000小时/hour



产品介绍 - 娱乐升降机/Product Introduction - Entertainment Lift



大间距一体式双吊点自动排绳升降机

Large pitch integrated double lifting point automatic rope lift

技术参数/Technical parameters

供电电源/Power supply: 380V/50Hz,2.3KW/2.9KW/4.4KW/
5.5KW/7.5KW

额定载荷/Power supply : 300kg/400kg/500kg/600kg/800kg

额定提升速度/Rated lifting speed : 0.3m—0.5/s

标准行程/Standard itinerary : 8m

统使用寿命/System service life : 3000小时/hour

钢丝绳使用寿命/Wire rope service life : 500小时/hour

防坠绳使用寿命/Anti-fall rope service life : 1000小时/hour

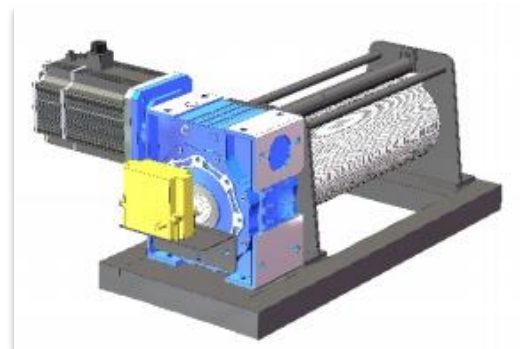

一体式双吊点自动排绳升降机

Integrated double lifting point automatic rope lift

技术参数/Technical parameters

供电电源/Power supply: : 380V/50Hz,2.3KW/2.9KW/4.4KW/
5.5KW/7.5KW

额定载荷/Power supply : 300kg/400kg/500kg/600kg/800kg

额定提升速度/Rated lifting speed : 0.3m—0.5/s

标准行程/Standard itinerary : 8m

统使用寿命/System service life : 3000小时/hour

钢丝绳使用寿命/Wire rope service life : 500小时/hour

防坠绳使用寿命/Anti-fall rope service life : 1000小时/hour



产品介绍 - 娱乐升降机/Product Introduction - Entertainment Lift

运用领域：轻型灯光架、LED屏幕、灯条、灯具等低载荷设备

Application areas: light light stands, LED screens, light strips, lamps and other low-load equipment

- ★高速总线绝对值伺服制动电机驱动/ High-speed bus absolute value servo brake motor drive
- ★内置行程限位开关/Built-in stroke limit switch
- ★无极导电环/信号环/ Electrodeless conductive ring/signal loop
- ★柔性电缆自动排线/Automatic routing of flexible cables
- ★亚光黑机箱/Matte black chassis



单吊点一体式高速升降机

Single lifting point integrated high-speed lift

技术参数/Technical parameters

供电电源/ Power supply: 220V/50Hz,750W

额定载荷/ Load rating: 25kg

额定提升速度/Rated lifting speed: 1.5m/s

标准行程/ Standard itinerary: 7.5m

系统使用寿命/ System lifetime: 2000小时/hour

柔性线使用寿命/ Flexible wire service life: 300小时/hour



双吊点一体式高速升降机

Double lifting point integrated high-speed lift

技术参数/ Technical parameters

供电电源/ Power supply : 220V/50Hz,750W

额定载荷/ Load rating : 45kg

额定提升速度/ Standard itinerary : 0.8m/s

标准行程/ Standard itinerary : 7.5m

系统使用寿命/ System lifetime : 2000小时/hour

柔性线使用寿命/ Flexible wire service life : 300小时/hour



产品介绍 - 威亚/ WIA

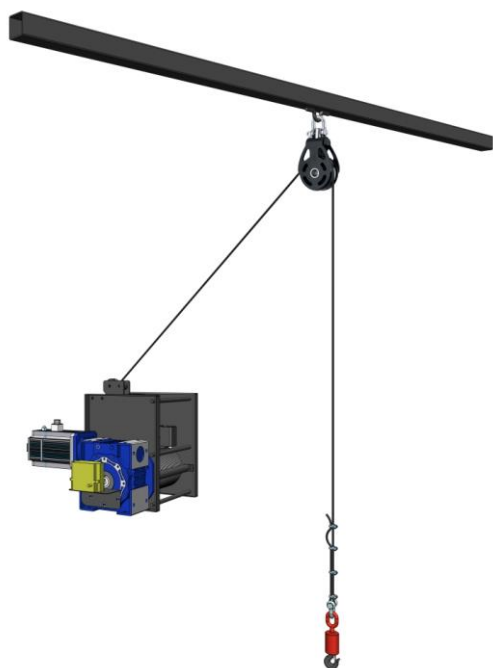

技术参数 / Technical parameters

电压/评率 Voltage/rating : 380v 50Hz
提升重量 /Lifting weight : 200-400kg
升降速度 /Lifting speed: 0.005-0.5m/s
定位误差 /Positioning error: ± 5 cm
吊点数目 /The number of lifting point: 1-2个
噪音 /The noise: < 50dB

1.单点吊机就是威亚特技 (Wire) , 空中飞人;
2.威亚技术用于舞台演出上, 运用舞台机械实现天马行空的飞天动作, 威亚与舞蹈、武术、杂技、影视武打相结合, 在舞台上展现出一人飞天、双人齐飞、多人齐飞的壮观场面;
3.威亚系统主要由吊杆机及吊杆机控制台组成。一般为分单吊点、双吊点两种形式, 可以变速、匀速升降。

1. The single-point crane is Wiya Stunt (Wire), trapeze;
2. WIA technology is used in stage performances, using stage machinery to achieve imaginative flying movements, WIA is combined with dance, martial arts, acrobatics, film and television martial arts, showing a spectacular scene of one person flying into the sky, two people flying together, and many people flying together on the stage;
3. WIA system is mainly composed of boom machine and boom machine console. Generally, it is divided into two forms: single lifting point and double lifting point, which can be variable speed and uniform speed lifting





产品介绍 -舞台演出 / 升降舞台-Stage performances / lifting the stage

线性驱动系统、平稳、精确、噪音低、基坑浅；
可承受其额定载荷的5-10倍、承受三个方向的动态载荷、
达5-6万个循环、结实、耐用；
后期维护简单方便（只需打扫灰尘和上油）。

Linear drive system, stable, accurate, low noise, shallow foundation pit;
It can withstand 5-10 times its rated load, withstand dynamic loads in three directions, up to 50,000-60,000 cycles, and is strong and durable;
Simple and convenient maintenance (Just Sweep the dust and oil)

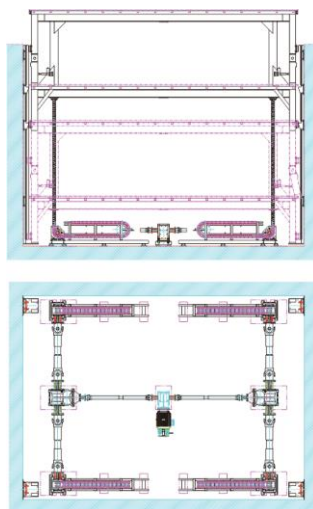

1.刚性链升降，是一种线性驱动系统、平稳、精确、无噪音、广泛用于舞台结构的升降、观众席地板、讲坛、隔声门等；

2.刚性链升降台、刚性链舞台，是一款罕见的结实、耐用的产品，它的寿命周期很长，达5-6万个循环，这相当于近30年的使用年限。产品的安全系数很高，可以承受的载荷为其额定载荷的5-10倍，此外，刚性链升降可以同时承受三个方向的动态载荷，即使在海上邮轮或地震环境也是非常安全的，因此，刚性链出现问题的几率很小。刚性链的后期维护也很简单，只需定期扫除灰尘和上油即可；

3.刚性链升降台，刚性链舞台，最大的特点是基坑浅，噪音低，这让它成为剧场应用的理想选择。利用浅基坑的产品，可以为业主节省一定的建筑空间，从而降低成本。

1.Rigid chain lifting, is a linear drive system, stable, accurate, no noise, widely used in the lifting of stage structure, auditorium floor, pulpit, soundproof door, etc;

2.Rigid chain lifting platform, rigid chain stage, is a rare strong, durable product, its life cycle is very long, up to 50,000 to 60,000 cycles, which is equivalent to nearly 30 years of service life. The safety factor of the product is very high, and the load can withstand is 5-10 times of its rated load. In addition, the rigid chain lifting can withstand dynamic loads in three directions at the same time, which is very safe even in the Marine cruise ship or seismic environment. Therefore, the probability of problems of the rigid chain is very small. The late maintenance of the rigid chain is also very simple, as long as the dust is cleaned and oiled regularly;

3.Rigid chain lift platform, rigid chain stage, the biggest feature is the shallow foundation pit, low noise, which makes it an ideal choice for theater applications. The use of shallow foundation pit products, can save a certain building space for the owner, thus reducing the cost.



产品介绍 -智能旋转灯架/ Intelligent rotating light stand

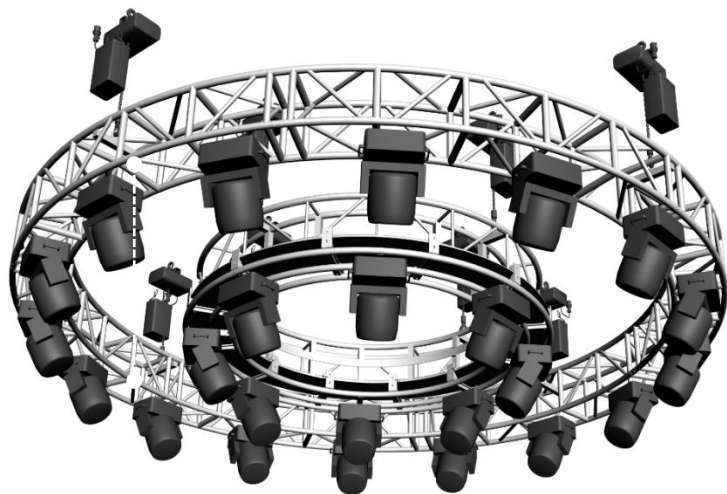

SIZE: Φ 1.2m , Φ 1.5m , Φ 2m, Φ 3m, Φ 4m, Φ 5m, Φ 6m, Φ 7m, Φ 8m, Φ 9m

智能旋转灯架易于搭建，便于安装，精准定位，360度无极旋转，DMX512信号控制，与灯光形成一个完整的DMX控制系统，让灯光动起来。灯架可水平或竖直与及倾斜使用，适用于电视台、酒吧、巡回演唱会、大型派对、音乐节、展示展览、商业庆典等场所。

The intelligent rotating light truss is easy to build, easy to install, precise positioning, 360-degree infinite rotation, DMX512 signal control, and the light form a complete DMX control system to make the light move. The light stand can be used horizontally or vertically and tilted, suitable for TV stations, bars, concert tours, large parties, music festivals, exhibitions, commercial celebrations and other places.





产品介绍 -舞台演出 /常用舞台机械/Common Stage Machinery

目前我们公司生产的KLT系列升降舞台、旋转舞台、伸缩舞台、旋转升降舞台等舞台机械主要应用于各类剧场、会展中心、电视演播厅、体育场馆等文化娱乐场所。由于采用了国内外先进的技术，产品精度高，运行平稳、安全、噪声小，满足了用户使用的要求。

At present, the KLT series lifting stage, rotating stage, telescopic stage, rotating lifting stage and other stage machinery produced by our company are mainly used in various theaters, convention and exhibition centers, TV studios, stadiums and other cultural and entertainment venues. Due to the use of advanced technology at home and abroad, the product has high precision, stable operation, safety and low noise, which meets the requirements of users.



升降旋转舞台/Lifting and rotating stage



伸缩舞台 Telescopic stage

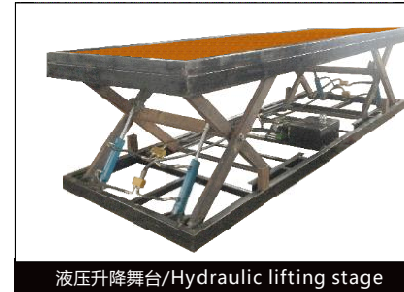

液压升降舞台/Hydraulic lifting stage



丝杆升降舞台/screw lifting stage



产品介绍 -舞台演出 / 电动吊杆-Electric Lifting Machine

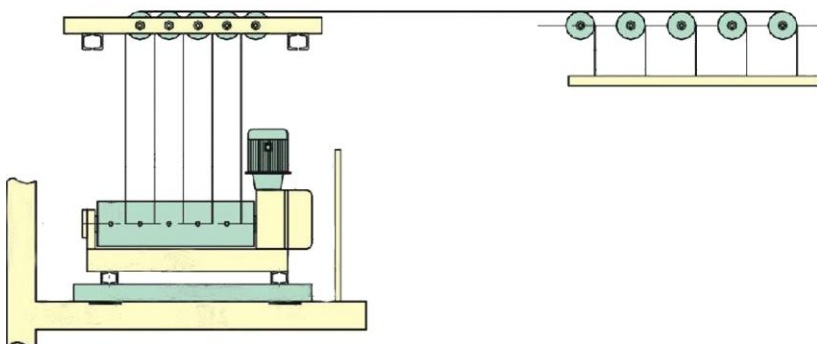

电动吊杆机基本参数

钢丝绳单层卷绕, 适合水平垂直方向安装;
速度: 0.01-1m/s(变频调数);
承载: 300kg/450kg/600kg/800kg/1000kg;
行程: 最大22米;
吊点: 4-8个;
噪音: < 50dB。

Electric Lifting Machine Basic Parameters
Wire rope single winding, suitable for horizontal and vertical direction installation.
Speed: 0.01-1m/s(frequency conversion);
Host: 300 kg / 450 kg / 600 kg / 800 kg / 1000 kg;
Stroke: Max 22 meters;
Hoisting points: 4-8;
Noise: < 50dB.

电动吊杆/ Electric Lifting Machine

- 1.设有热保护装置交流异步电动机, 绝缘登记F级, 防护等级IP54;
- 2.独立双制动器, 设有手动释放装置;
- 3.无缝钢管精加工卷筒;
- 4.限位和超程保护, 可提供高精度定位;
- 5.编码器提供精确地位置检测和速度检测。

1. Equipped with thermal protection device AC asynchronous motor, insulation registration F grade, protection grade Ip54;
- 2.Independent double brakes, equipped with manual release device;
3. Finished reel of seamless steel pipe;
- 4.Limit and overtravel protection can provide high-precision positioning;
- 5.The encoder provides precise position detection and speed detection.





产品介绍 -舞台演出 / 伸缩看台- Stage performances / telescopic stands

活动看台拉伸成台阶形时，翻起座椅供观众舒适地欣赏节目，收缩成匣子状时则占有用很少的空间，让出场地，可安排他用。充分利用室内的有限面积，满足不同使用功能情况下的多座位要求。活动看台操作控制方便，功能配置灵活，结构设计优异，款式美观大方。具有负载能力大、安全措施可靠、定位准确、维修方便、噪音小等特点。

When stretched into stands, audience could flip seats and sit comfortably to enjoy performance; when contracted into box, it provides space for other use. Making full use of the limited internal area to meet different multi-seat requirement. Easy operation, flexible configuration, excellent design, elegant appearance. Vast capacity, reliable safety measures, accurate positioning, easy maintenance, low noise.

行走转动系统/Transmission System

- 1.驱动电动安装在平台第一排下部，通过摆针轮减速电机的输出轴，以轴、链轮、链条将动力传递给摩擦驱动轮；
- 2.防走偏同步机构：为防止伸缩看台运行时，由于制造、安装及地面不平、误差等原因造成左右跑偏，于相邻走轮架间装有链轮、链条、及同步连杆组成的机械反馈式同步装置，以确保伸展与回缩过程中无滞后及定向跑偏现象；
- 3.看台底部采用双轴承耐磨聚氨酯铁芯轮，即能承受重压，又能解决底轮与地面间的摩擦所产生的磨损，承受巨力不磨损底板；
- 4.采用高精度轴承和优质链条传动，使看台运行平稳。

1. Drive motor equipped under the first row decelerates output shaft through pin wheel, transfer power to friction drive wheel by shaft, sprocket and chain.
2. Anti-deviation synchronization mechanism: Configured with sprockets, chains, and synchronous feedback device between adjacent moving wheels. Ensuring there is no lag and directional deviation when extending and retracting due to causes of manufacturing, installation, uneven ground, error, etc;
3. Dual wheel bearing made of polyurethane, able to withstand pressure, also solving the friction and wear between wheel and the ground;
4. High-precision bearings and quality chain drive, facilitating stable and smooth operation.

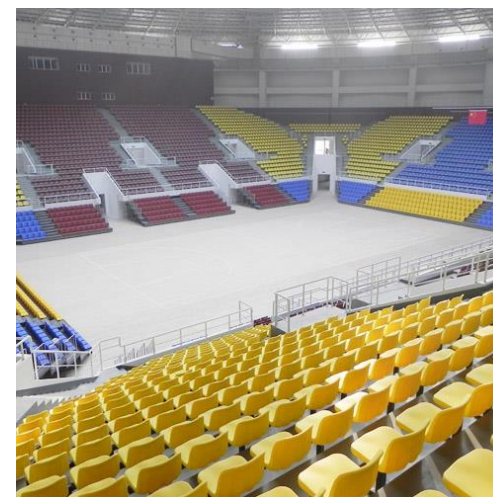



产品介绍 -舞台演出 / 伸缩看台- Stage performances / telescopic stands

电气系统/Electrical System

- 1.看台后装有电源控制箱，按钮控制整个看台的伸展与收缩。
- 2.采用三相电机，功率：750W，转速：1400转/分。
- 3.有过载保护和漏电保护。

1. A power control box is installed behind the stands, the buttons control the extension and contraction of the entire stand.
2. Using three-phase motor, power: 750W, speed: 1400 rpm.
3. With overload protection and leakage protection.

床架结构/Frame structure

床架由刚骨架结构及骨架上的台面组成

- 1.床架主结构经焊接铆成型，型材形式为：冷弯内卷边钢槽，高频焊接方管，矩形管，主结构钢板厚度3mm，钢骨架结构件之间用螺栓连接，床架设计牢固耐用。钢骨架抗荷载等级：承受设备自重、承受活荷载 $350\text{kg}/\text{M}^2$ ，横向摆动荷载 $350\text{N}/\text{M}^2$ 。
- 2.骨架结构金属表面做防腐处理：经打磨、清理飞溅物，然后涂防锈漆一层及表面漆一层，表面颜色可选择。
- 3.床架台面采用15夹板，上面覆盖PVC地毯，表面平整，强度高，不会因气候差异而产生表面起泡现象。
- 4.每层台阶左右前三面采用条纹防滑铝钛合金装修包覆，装修条转角处采用塑料套件覆盖，即增加承受强度，又增添美观性。
- 5.床架前沿镶嵌防滑耐磨的橡胶胶条，特殊的固定方式使之不会脱落，保护铝条和防止观众滑倒。
- 6.床架周边有栏杆保护。

Composed by steel structure and board.

- 1.Main structure by welding and riveting 3mm thick steel, connected by bolts, with load capacity of $350\text{KG} / \text{m}^2$ besides the weight of device.
2. Anti-corrosion surface handling: polished, coated with rust paint and painted another finish color according to customer needs.
- 3.Board made of 15 plywood, covered with PVC carpet, smooth surface, high strength, no blistering under different climates.
- 4.Left, right and front three dimensions are covered with striped anti-slipping aluminum strips, corners with plastic parts, maintaining high strength and adding beautiful outlook.
- 5.Frontier wears anti-slipping rubber strip, protecting aluminum strip and providing audience safety.
- 6.Guardrail protected.

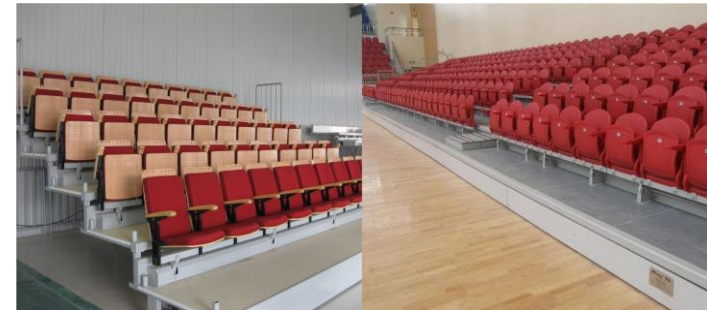



产品介绍 -舞台演出 / 伸缩看台- Stage performances / telescopic stands

可拆卸组合拼装看台/Detachable combination assembled stand

科励宝可拆卸组合拼装看台是一种新型的看台系统，整体结构采用标准件、模块化设计，看台的各种部件，如支架，踏板，侧板，护栏，座椅等，皆可随意搭配组装，可根据场地及观众席位需要进行各种层高、位数的拼装组合。具有结构简单，搭建及拆卸方便，便于运输及储存等特点，可广泛应用于体育场馆，演艺活动，各种公开活动等需要搭建观众看台的场所。

1.看台的结构设计，根据中华人民共和国国家标准(GB50009-2001)建筑结构荷载规范，结合中华人民共和国文化行业标准(WH/T 42-2011)演出场所安全技术要求第2部分临时搭建演出场所、看台安全技术要求为依据，荷载按GB50017-2003和JGJ61-2003进行杆件承载力验算，以保证安全使用。

2.看台钢结构支架全部采用LAHER(雷亚架)铸件接头插销式快速安装结构制作，根据要求组合成多级模数的临时看台，规格为250/300/350/400mm(层高)x800/900mm(层深)，座椅中心距500mm。侧栏杆和背护栏高度均为1100mm，栏杆的受力强度满足GB50009-2001的相关要求，该结构看台可以搭配低靠背或中靠背注塑椅或自动折叠式座椅，室内场所可搭配礼堂椅，安装简易方便。层架采用焊接整体模块设计，所有部件可以交换通用。

The detachable combined assembly stand of Coreat is a new type of grandstand system, the overall structure adopts standard parts, modular design, various components of the stand, such as brackets, pedals, side panels, guardrails, seats, etc., can be assembled at will, according to the needs of the venue and spectator seats of various floor heights, number of assembled combinations. It has the characteristics of simple structure, easy to build and disassemble, easy to transport and store, etc., and can be widely used in stadiums, performing arts activities, various public activities and other places that need to build spectator stands.

1. The structural design of the grandstand, according to the national standard of the People's Republic of China (GB50009-2001) building structure load specification, combined with the People's Republic of China cultural industry standard (WH/T 42-2011) performance venue safety technical requirements Part 2 temporary construction of performance venues, grandstand safety technical requirements as the basis, the load according to GB50017-2003 and JGJ61-2003 member bearing capacity verification to ensure safe use.

2. The steel structure bracket of the grandstand is all made of LAHER (Leia frame) casting joint pin type quick installation structure, which is combined into a multi-level modular temporary stand according to the requirements, with a specification of 250/300/350/400mm (floor height) x 800/900mm (layer depth), and the seat center distance is 500mm. The height of the side railing and the back railing is 1100mm, the force strength of the railing meets the relevant requirements of GB50009-2001, the structure of the stand can be equipped with low backrest or middle backrest injection chairs or automatic folding seats, indoor places can be matched with auditorium chairs, easy and convenient installation. The shelf adopts a welded integral module design, and all parts can be exchanged universally.





产品介绍 -舞台演出 / 伸缩看台- Stage performances / telescopic stands

可拆卸组合拼装看台/Detachable combination assembled stand

3.踏板采用优质碳素防滑花纹钢踏板或防火防潮防滑舞台板，每平方米可承重400kg。拼装看台的层数、位数及高度可根据客户要求设计，一般不超过12层。整体钢支架结构可根据客户使用条件的不同，采用静电喷涂处理或镀锌处理，提高看台的使用寿命。

3. The pedal adopts high-quality carbon non-slip pattern steel pedal or fire-proof, moisture-proof and non-slip stage board, which can bear 400kg per square meter. The number of floors, digits and height of the assembled stands can be designed according to customer requirements, and generally does not exceed 12 floors. The overall steel support structure can be treated with electrostatic spraying or galvanizing according to the different conditions of customers to improve the service life of the stands.

可拆卸拼装看台的特点/Removable assembled grandstand features:

- 1.基本结构及专用部件全部采用标准化模块化设计;
- 2.结构少，搭建及拆卸方便，还可设置遮阳篷;
- 3.接头构造合理，作业容易，轻巧简便;
- 4.承载能力大，结构强度高，整体稳定性好，安全可靠;
- 5.采用独立楔形插销，插件有自锁功能，可通过插拔插销进行锁定或拆卸;
- 6.构件系列标准化，便于运输和管理;
- 7.拼装及拆卸简单方便，广泛用于各类活动场地;
- 8.看台座椅可采用塑料座椅及铝合金座板或其他结构座椅，满足各种场合需要。

1. the basic structure and special parts are all standardized modular design.
2. less structure, easy to set up and dismantle, also set the awning.
3. the joint structure is reasonable, the job is easy, lightweight and easy.
4. carrying capacity, high structural strength, good overall stability, safety and reliability.
5. using an independent wedge bolt, plug-ins have self-locking function can be locked or disassembled by mating plug.
6. component series of standardized, easy to transport and management.
7. easy assembly and disassembly, widely used in various venues.
8. can be plastic seat grandstand seats and aluminum base plate or other structure of the seat, to meet the needs of a variety of occasions.

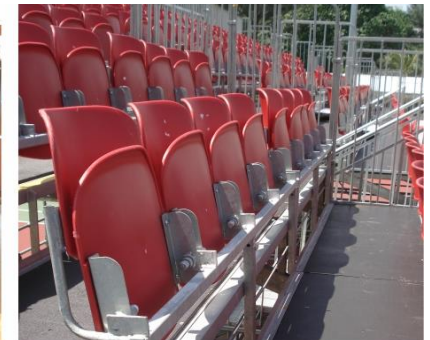



产品介绍 - 屏幕机械/Screen mechanics



开合屏机械/Opening and closing screen machinery

产品特点: 绝对值伺服电机, 齿轮减速机传动机构, 特殊定制吊装式直线高精度导轨, 高精度导向电动推杆, 可编程程序控制

Product features: absolute value servo motor, gear reducer transmission mechanism, special customized hoisting linear high-precision guide rail, high-precision guided electric actuator, programmable program control

产品参数/Product parameters:
型号/Model: 定制/customize
工作效率/Efficiency: 95%,
单边负载/One-sided load: 100-1000kg,
定位精度/Positioning accuracy: $\pm 0.5\text{mm}$,
开合速度/Opening and closing speed: 0.01—0.2m/s



XY轴弧形开合屏机械/XY axis arc opening and closing screen machinery

产品特点: 绝对值伺服电机, 齿轮减速机传动机构, 特殊定制吊装式弧形高精度导轨, 多种模式可编程程序控制。

Product features: absolute value servo motor, gear reducer transmission mechanism, special customized hoisting arc high-precision guide rail, multiple modes programmable program control.

产品参数//Product parameters:
型号/Model: 定制/customize
工作效率/Efficiency: 95%
单边负载/One-sided load: 100-1000kg
定位精度/Positioning accuracy: $\pm 0.5\text{mm}$
开合速度/Opening and closing speed: 0.01—0.2m/s



开合旋转屏机械/Opening and closing rotating screen machinery

LED画面可以瞬间完成画面的转换。方便、快捷、省力, 画面播放任何可以想象到的画面, 可动态、静态、写实、写意、内容丰富多彩, 且画面效果也更生动逼真能呈现更好的舞台效果。给观众带来视觉上的完美享受。适用于: 展馆展厅等。

The LED screen can complete the screen conversion in an instant. Convenient, fast, labor-saving, the picture plays any imaginable picture, can be dynamic, static, realistic, freehand, colorful content, and the picture effect is more vivid and realistic can present a better stage effect. Bring visual perfection to the audience. Suitable for: exhibition hall, etc.



产品介绍 - 屏幕机械/Screen mechanics



伸缩球机械/Telescopic ball machinery

- 1.外观上很有吸引力，随意的分区播放，可以同步或异步伸缩；
- 2.360度欣赏每个视角，带给人们视觉上震撼的冲击力；
- 3.方便、健康环保，性能可靠；
- 4.博物馆，科技馆及娱乐场所的最佳选择。

1. The appearance is very attractive, random partition playback, can be synchronous or asynchronous scaling;
2. 360 degree appreciation of each perspective, bringing people a visually stunning impact;
3. Convenient, healthy and environmentally friendly, reliable performance;
4. The best choice for museums, science and technology museums and entertainment venues.

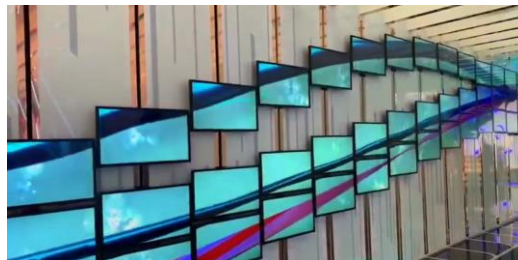

升降屏机械/Lifting screen machinery

- 1.静音链轮、静音链条传动，每一个屏可以单独的系统控制；
- 2.多种运动组合的方式、运动流畅不卡顿、运行速度平稳、可以极大吸引人们的眼球；
- 3.画面非常具有动感，屏幕分辨率高清不失真；
- 4.可以根据实际的场地制定，系统调试方便，只要求编排升降动作即可。
- 5.升降屏适用于：展览展示厅。

1. Silent sprocket, silent chain drive, each screen can be controlled by the system separately;
2. A variety of sports combination methods, smooth movement without stuttering, smooth running speed, can greatly attract people's attention;
3. The picture is very dynamic, and the screen resolution is high-definition without distortion;
4. It can be formulated according to the actual site, the system debugging is convenient, and it is only necessary to arrange the lifting action.
5. Lifting screen is suitable for: exhibition hall.

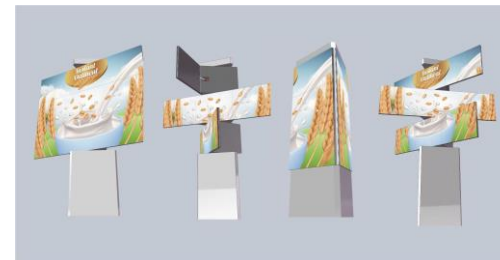

户外旋转折叠屏机械/Outdoor rotating folding screen machinery

- 1.立柱式新媒体设备，旋转折叠LED屏，上下分割三块屏幕；
- 2.且屏幕可根据画面随意分割，根据场景需要定制；
- 3.组合形式多变，360度视角动态观看，又可作为3D立体展示。
- 4.户外旋转折叠屏适用于：商业广场、电影剧院、航空机场、高铁车站、汽车4s店、产业园区科技展馆等。

1. Column-type new media equipment, rotate and fold LED screen, and divide three screens up and down;
2. And the screen can be divided at will according to the picture, customized according to the needs of the scene;
3. The combination form is changeable, 360-degree view dynamic view, and can be displayed as 3D stereoscopic.
4. Outdoor rotating folding screen is suitable for: commercial squares, movie theaters, aviation airports, high-speed rail stations, automobile 4S shops, industrial park science and technology exhibition halls, etc.



产品介绍 - 屏幕机械/Screen mechanics



翼展屏机械/Wingspan screemachinery

1. 立柱式/悬吊式新媒体设备，正反双弧两面LED屏，上下分割五块屏幕；
2. 且屏幕可根据画面随意分割，根据场景需要定制；
3. 具有指向导视功能、360度视角动态观看，又可作为3D立体指示牌
4. 翼展屏适用于：影剧院、体育馆、旅游景区、车站导视、汽车4s店等。

1 column/pendant new media equipment, front and back double arc two-sided LED screen, five screens divided above and below;

2. And the screen can be divided at will according to the picture, customized according to the needs of the scene;

3. With guidance function, 360-degree viewing angle dynamic viewing, and can be used as a 3D stereoscopic sign

4. The wingspan screen is suitable for: movie theaters, gymnasiums, tourist attractions, station guides, car 4S shops, etc.



魔方柱机械/Rubik's Cube column machinery

1. 由三个led显示屏魔方箱体组成，每个箱体都可以像魔方一样360度旋转，在不同的时间多样转动、最后定格在一个平面，呈现三个画面；
2. 更具有动感和视觉冲击力，也提高了产品的档次，广告形式新颖，提升广告的创意，更好的为企业带来商业价值。
3. 魔方柱适用于：商业广场、电影剧院、航空机场、高铁车站、汽车4s店、产业园区科技展馆等。

1. It is composed of three LED display cube boxes, each box can rotate 360 degrees like a Rubik's cube, rotate at different times, and finally freeze on a plane to present three pictures;

2. More dynamic and visual impact, but also improve the grade of products, advertising form novelty, enhance advertising creativity, better for the enterprise to bring commercial value.

3. Rubik's Cube column is suitable for: commercial squares, movie theaters, aviation airports, high-speed rail stations, automobile 4S shops, industrial park science and technology exhibition halls, etc.



波浪屏机械/Wave screen machinery

1. 波浪屏是一款创意伸缩矩阵屏，每个模块可自由伸缩，独立运动模块，通过电机动实现凹凸伸缩变化的动感效果让物理上动感和视频创意完美结合，实现画面自由创意、场景的多样化；
2. 视觉效果冲击人们的眼球，能很好的达到广告效果，而且产品高级新颖，有利于提升企业的形象。
3. 波浪屏适用于：CDB商圈、休闲娱乐场所、舞台滑动现场、展馆展厅等。

1. Wave screen is a creative telescopic matrix screen, each module can be freely retracted, independent motion module, through the motor drive to achieve the dynamic effect of concave and convex expansion and expansion changes, so that the physical motion and video creativity are perfectly combined, to achieve the free creativity of the picture, the diversification of scenes;

2. The visual effect hits people's eyes, can achieve the advertising effect well, and the product is advanced and novel, which is conducive to enhancing the image of the enterprise.

3. Wave screen is suitable for: CDB business district, leisure and entertainment venues, stage sliding scenes, exhibition halls, etc.



Coreat



服务领域 Service areas

科励宝产品用于礼堂剧院、酒吧派对场、展览展示厅、体育场馆、文旅项目、流动演出等，专业团队全程沟通对接前后期细节，做到每个项目都进行跨部门沟通，发挥团队力量，更好的为客户提供全方位解决方案。Coreat products are used in auditorium theaters, bar parties, exhibition halls, stadiums, cultural tourism projects, mobile performances, etc., professional teams communicate with the details before and after the whole process, so that each project can communicate across departments, give full play to team strength, and better provide customers with all-round solutions.



展览展示厅
Exhibition hall



礼堂剧院
Auditorium Theatre



文旅项目
Cultural tourism projects



酒吧派对场
Bar party venue



体育场馆
Sports venues

体育



娱乐项目案例/Entertainment project examples



未来酒吧



莱恩

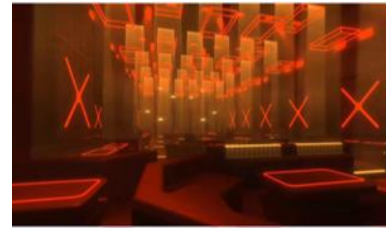

星汇



GTM



乌兰浩特



LIVEHOUSE



HEPBURN CLUB



秦·PARTY



CLUB-X VEGAS



AM TANG



星际



MONSTER CLUB



星际



GT



M-KINGDOM

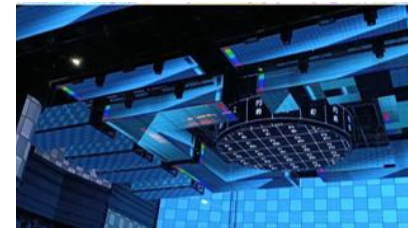

苏威



娱乐项目案例/Entertainment project examples



ET-HOUSE



SPAC



MILK PLUS



H-BOMB



MIAMI



K+CLUB



H-CLUB



MIAMI



OSCAR



ATLANTIS CLUB



SUPER FACE CLUB



SPACE CLUB



TNT CLUB



TOP ONE CLUB



CLUB HI CLUB



BB FACECLUB



娱乐项目案例/Entertainment project examples



ELEVEN CLUB



BASE CLUB



BASS CLUB



菲芭



TNT



ID-X



格莱美派对



MAX



PARTY MIX



LAFETE PLUS



MIILAN SCALA



DREAM HOUSE



ECHO



NEWFACE



W妃吧



DREAM HOUSE CLUB



娱乐项目案例/Entertainment project examples



M2



TIGER



MIAMI



DZ



MIAMI

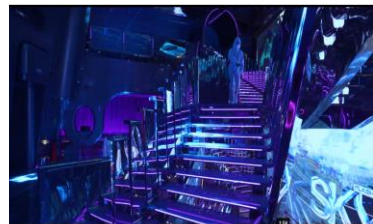

天空之城



OASIS OFFICIAL



HI CLUB OFFICIAL



E+PARTY



地标酒吧



LIVE PLUS



XH



DTWO CLUB



NICE CLUB



VG



零柒



娱乐项目案例/Entertainment project examples



MYTH.PLUS



郑州-梦田



CLUB 'LAS'VEGAS' CHENZHOU



FLOW



12 BEAST LAB



CLUB LAS VEGAS

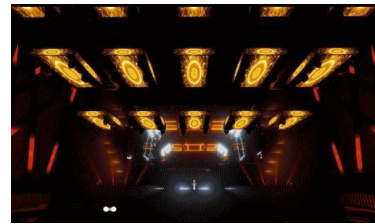

OSCAR



百色-JX

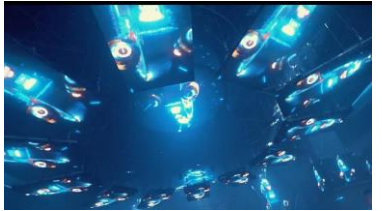

H-PARTY ROOM



广州花都 "PIU" 综合体



OASIS OFFICIAL



CLUB LAS VEGAS



SPACE



OWL PARTY



M2

礼堂剧院/Auditorium Theatre



百色干部学院--Bose Cadre Academy



厦门康乐小学--Xiamen Recreation Primary School



深圳人大附中--Shenzhen People's Congress High School



松山湖中心小学--Songshan Lake Central Elementary School



中央戏剧学院-- Central Academy of Drama



西安诸葛古镇出师表剧场--Xi'an Zhuge Ancient Town is a master of the Table Theater



广州军区剧院--Guangzhou Military Region Theater



广州军区预备役炮兵部队--Reserve artillery unit of the Guangzhou Military Region



广州军区75770部队--Unit 75770 of the Guangzhou Military Region



广东省文化馆--Guangdong Provincial Cultural Center



珠海市文化馆--Zhuhai Cultural Center



演出项目案例/Performance project case

演播室/Exhibition

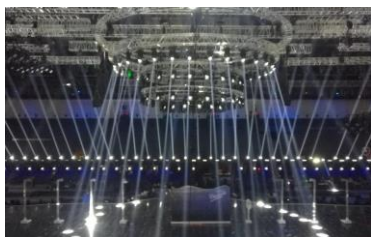

湖南电视台--Hunan TV



扬州电视台--Yangzhou TV



卡塔尔半岛电视台演播室--Al Jazeera studio in Qatar



埃及电视台--Egyptian television

户外演出/Outdoor gigs



武汉欢乐谷--Happy Valley Wuhan



深圳欢乐谷--Happy Valley Shenzhen



成都欢乐谷--Happy Valley Chengdu



海南长影环球100--Hainan Changying Global 100



中山古镇国际灯光节
--Zhongshan Ancient Town International Light Festival



开平文化广场--Kaiping Cultural Square



展览展示项目案例/Exhibition shows project cases

展览展示厅/Exhibition hall



深圳燃气展厅--Shenzhen gas exhibition hall

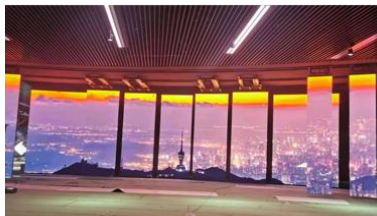

深圳市当代艺术与城市规划馆--Shenzhen Museum of Contemporary Art and Urban Planning



宝安区-湾区新技术新产品展示中心--Bao'an District-Bay Area New Technology and New Products Exhibition Center



广州北京路国家级文化产业示范园区--Guangzhou Beijing Road National Cultural Industry Demonstration Park



中山星光联盟灯饰博览中心--Zhongshan Starlight Alliance Lighting Expo Center



华南大厦--Southern China Daxia



广州文德广场--Guangzhou Wende Plaza



东莞铂尔曼--Pullman Dongguan



南京青奥会--Nanjing Youth Olympic Games



北京城建智控展厅-- Beijing Urban Construction Intelligent Control Exhibition Hall



武汉中碳登大厦--Nanning International Convention and Exhibition Center

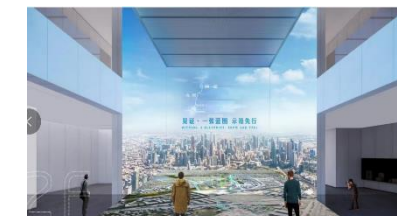

西安高铁东城城市展厅-- Xi'an high-speed railway Dongcheng City Exhibition Hall



展览展示项目案例/Exhibition shows project cases

体育场馆/Sports venues



德胜体育中心-- Desheng Sports Center



厦门奥体中心--Xiamen Olympic Sports Center



成都金强赛事中心--Chengdu Jinqiang Competition Center

《夜话柳江》40米直径环形舞台/"Night Talk Liujiang" 40-meter diameter circular stage

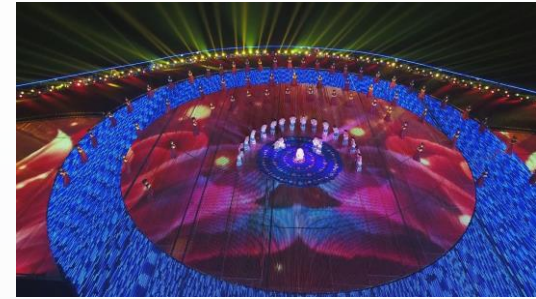
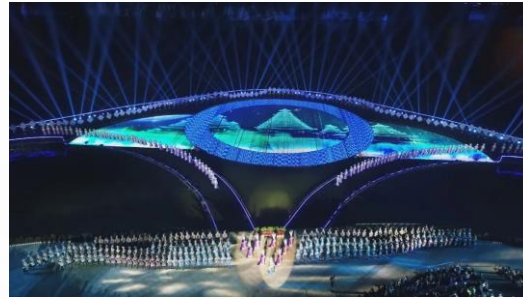



扫码关注, 可观看案例视频!
Scan the code to follow, you can
watch the case video!

+86 18824701468

<https://globalcoreat.com>

Email: info@globalcoreat.com

广东省广州市番禺区沙湾街青峰路2号
No. 2, Qingfeng Road, Shawan Street, Panyu District,
Guangzhou, Guangdong Province